

PROFIL KĄTOWY NAKŁADANY GLAX CORNER PROFILE - SURFACE MOUNTED ПРОФИЛЬ УГЛОВОЙ, НАКЛАДНОЙ

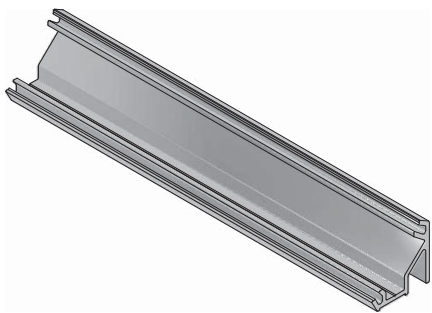

PARAMETRY / CHARACTERISTICS / ХАРАКТЕРИСТИКИ

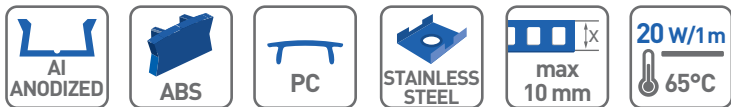

AKCESORIA / ACCESSORIES / АКЦЕССУАРЫ



PAKOWANIE / PACKING / УПАКОВКА



SKŁAD ZESTAWU / SET INCLUDES / КОМПЛЕКТАЦИЯ

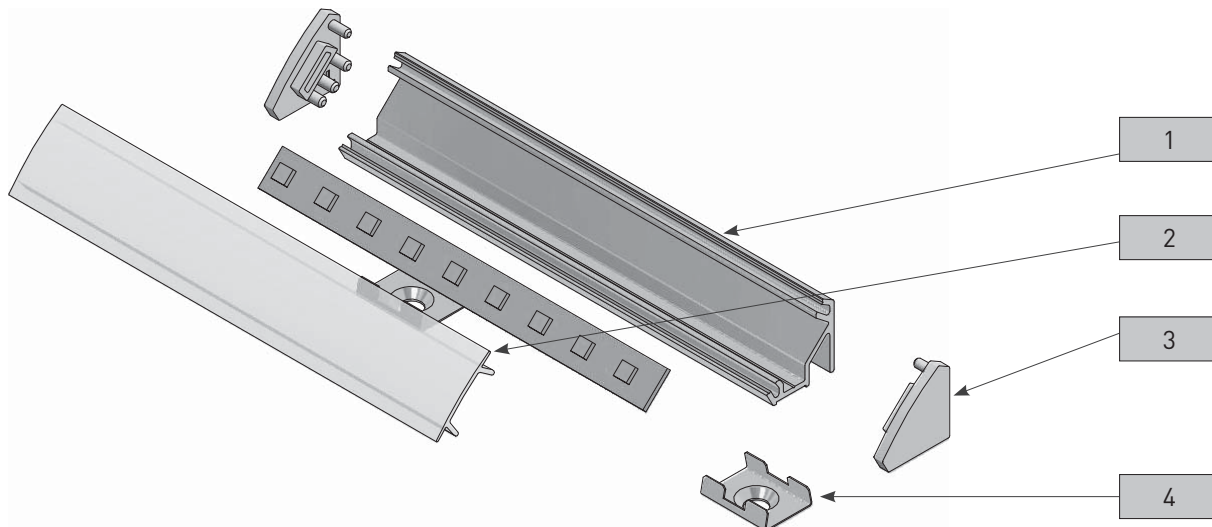

1

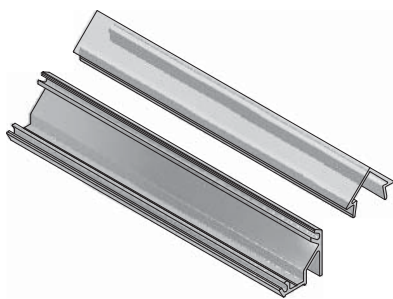

PA-GLAXNKKT-AL	●	2000
PA-GLAXNKKT-AL-20M	●	
PA-GLAXNKKT-AL-10	○	
PA-GLAXNKKT-AL-90	●	3007
PA-GLAXNKKT3M-AL	●	

2A

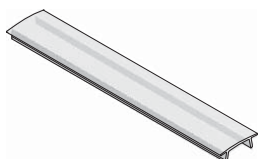

PA-OSMLGLAX-00	mleczna soft white	2000
PA-OSMLGLAX3M-00	белый матовый	3007
PA-OSTRGLAX-00	transparentna transparent	2000
PA-OSTRGLAX3M-00	прозрачная	3007

2B

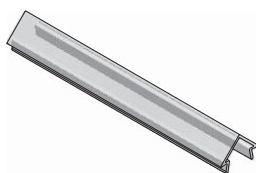

PA-OSMLGLAXT-00	mleczna soft white	2000
PA-OSMLGLAXT3M-00	белый матовый	3007

3A

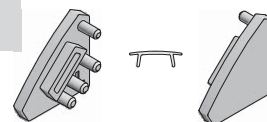

PA-ZASGLAXNKKT-00	●
PA-ZASGLAXNKKT-10	○
PA-ZASGLAXNKKT-90	●
PA-ZASGLAXNKKT-20M	●

3B

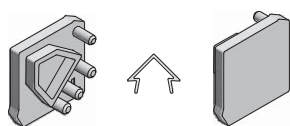

PA-ZASGLAXNKKT-00	●

4

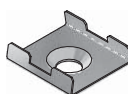

PA-SPRGLAXMIC-00	●

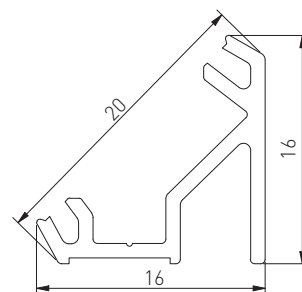

Dociąć ramiona uchwytu do wewnątrz
Bend the arms of the handle inwards
Согните ручки держателя внутрь

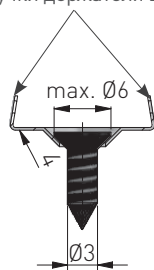

Montaż za pomocą uchwytu
Assembly using handle profile
Крепление с помощью держателя

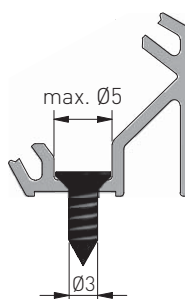
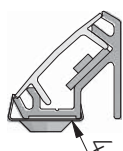

Montaż za pomocą wkrętu
Assembly using screws
Крепление с помощью винта

